



余姚市波大电器有限公司 Yuyao City Boda Electrical Appliances Co., Ltd.

地址:浙江余姚工业园区(朗霞街道新新村八字桥242号) 邮编Postcode.315480

Address:No 242 BaZi Qiao, XinXin Village, YuYao Industrial Area, Zheiiang Province

电话Phone: 0086-574-62266661 62266662 62266663

传真Fax:0086-574-62266664 网址Website: www.cnboda.com

邮箱E-mail: adam@cnboda.com

boda@cnboda.com



波大

BODA HAND PUMP

专业手压泵制造商
Professional Hand Pump Manufacturer

余姚市波大电器有限公司
Yuyao City Boda Electrical Appliances Co., Ltd.
<http://www.cnboda.com>



INTRODUCTION

Established in 1999, Yuyao Boda Electric Appliances Co., Ltd. is a professional manufacturer of water dispenser faucets. Our business scope includes the production, processing, and sales of plastic faucets, portable water pumps, food pumps, and other accessories for water dispensers and purifiers.

Our company has passed ISO 9001 and CGMP certifications. Our products, complying with multiple international certifications, such as CE, RoHS, and LFGB certifications, are distributed to over 50 countries, at home and abroad.

Excellent quality and customer satisfaction are our unremitting pursuits. Our thoughtful sales team, strong R&D capability, rigorous quality inspection system, and full-equity production line have been widely recognized by our customers. Besides, we provide OEM and ODM services to meet your customization needs.

Warmly expect to cooperate with you!



长江三角洲经济圈 Yangtze River Delta Economic Circle



Water pump A



Size:122X240mm
Weight: 377g
QTY:24pcs
G.W: 13 kgs
MEAS:52 X 38 X 57cm



Water pump A-1



Size:122X230mm
Weight: 335g
QTY:24pcs
G.W: 12.8 kgs
MEAS:52 X 38 X 57cm



Water pump A-2



Size: 122X245mm
Weight: 371g
QTY:24pcs
G.W: 13kgs
MEAS:52 X 38 X 57cm



Water pump B-1



Size:95 X 195mm
Weight: 190g
QTY:48pcs
G.W: 10.3kgs
MEAS:62 X 42 X 42cm



Water pump C



Size:110 X 205mm
Weight: 266g
QTY:24pcs
G.W: 10kgs
MEAS:53 X 37.5 X 45cm



Water pump C-1



Size:110X265mm
Weight: 372g
QTY:24pcs
G.W: 10.8kgs
MEAS:55.5 X 38 X 53.5cm



Water pump C-2



Size:110X222mm
Weight:346g
QTY:24pcs
G.W: 10.5kgs
MEAS:46.5X38X54cm



Water pump C-3



Size:110X213mm
Weight: 267g
QTY:24pcs
G.W:9.5kgs
MEAS:53 X 37.5 X 45cm



Water pump D



Size:110X232mm
Weight: 268g
QTY:24pcs
G.W: 10.5kgs
MEAS:53.5 X 38 X 51cm



Water pump E



Size:122X285mm
Weight: 435g
QTY:24pcs
G.W: 14.5kgs
MEAS:60X40X56.5cm



Water pump F



Size:86X166mm
Weight: 112g
QTY:60pcs
G.W: 11.5kgs
MEAS:52 X 38 X 53cm



Water pump G



Size:85 X 162mm
Weight: 141g
QTY:24 pcs
G.W: 5.4kgs
MEAS:39.5X37.5X32cm

Water pump G-1
● ● ●
Size: 94X172mm
Weight: 140g
QTY: 24pcs
G.W: 6.4kgs
MEAS: 38 X 34.5 X 41.5cm

Water pump H
Size: 160 X 90mm
Weight: 80g
QTY: 60pcs
G.W: 4.5kgs
MEAS: 46X37X52cm

Water pump J
Size: 92 X 213mm
Weight: 150g
QTY: 24pcs
G.W: 6.5kgs
MEAS: 46X32X42cm

Water pump K
Size: 122 X 240mm
Weight: 391g
QTY: 24pcs
G.W: 13.3kgs
MEAS: 52 X 38 X 57 cm

Water pump L
Size: 110 X 205mm
Weight: 281g
QTY: 24pcs
G.W: 10.2kgs
MEAS: 53 X 37.5 X 45cm

Water pump M
Size: 187 X 100mm
Weight: 105g
QTY: 50pcs
G.W: 7.0kgs
MEAS: 46 X 39 X 49 cm

Water pump N
Size: 85 X 185mm
Weight: 80g
QTY: 60pcs
G.W: 7.0kgs
MEAS: 46 X 39 X 49 cm

Water pump P
Size: 110X222mm
Weight: 325g
QTY: 24pcs
G.W: 11.5kgs
MEAS: 49.5X40.5X46.5cm

Water pump Q
Size: 110X240mm
Weight: 325g
QTY: 24pcs
G.W: 9.6kgs
MEAS: 52.5X47.5X36.5cm

Battery pump
● ● ●
Weight: 268g
QTY: 30pcs
G.W: 12.7kgs
MEAS: 77X37X43.5cm

Chargeable pump USB
● ● ●
Weight: 302g
QTY: 30pcs
G.W: 14.9kgs
MEAS: 73.5X37X43.5cm

Electric pump
● ● ●
Weight: 239 g
QTY: 30pcs
G.W: 15.6kgs
MEAS: 68 X 37 X 44cm

USB pump A
Size: 72X135mm
Weight: 215g
QTY: 24pcs
G.W: 7.9kgs
MEAS: 38X29X33.5cm

USB pump B
Size: 147X157mm
Weight: 280g
QTY: 24pcs
G.W: 9.6kgs
MEAS: 43X31.5X33.5cm

USB pump C
Size: 72X127mm
Weight: 235g
QTY: 24pcs
G.W: 8.0kgs
MEAS: 38X29X32cm

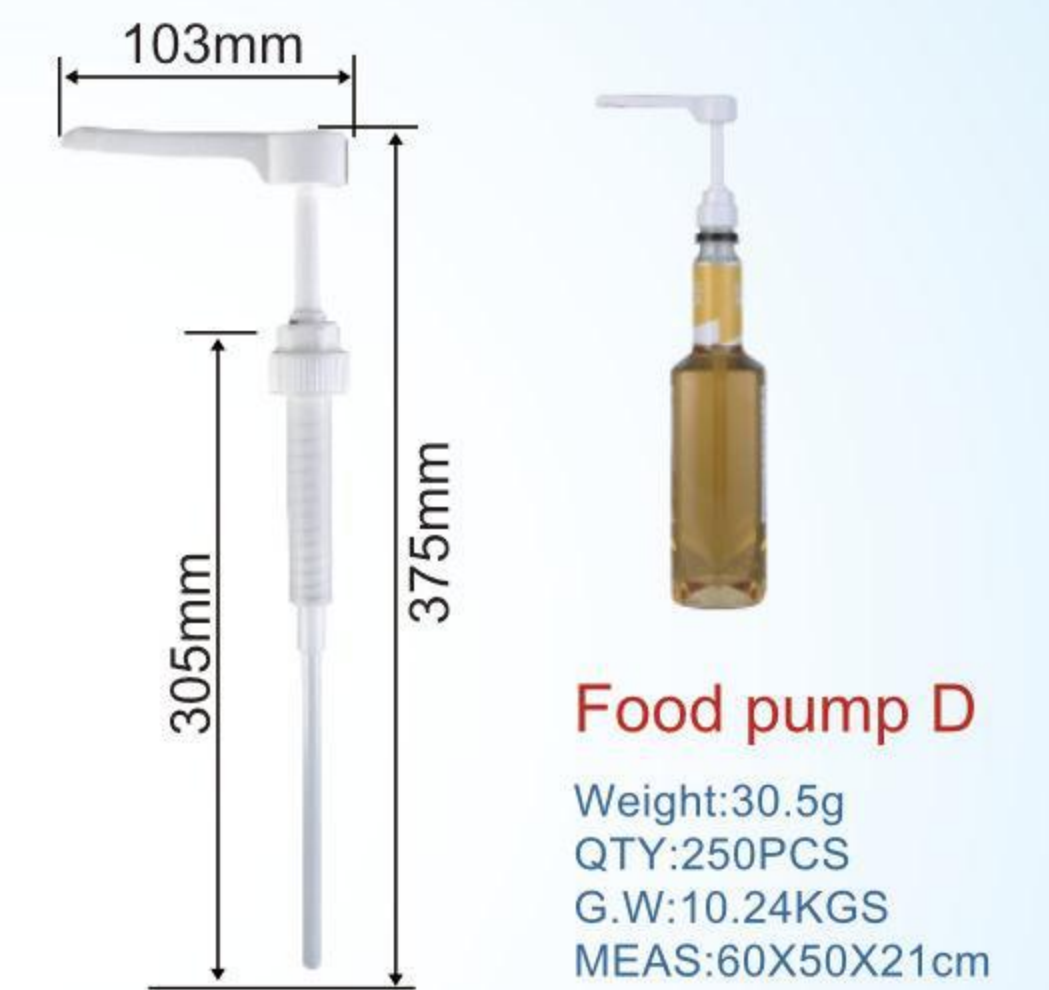



5L bottle
SIZE:
30.5×12.5×23cm

12L bottle
SIZE:
38×16.5×26cm

18L bottle
SIZE:
41×23.5×26cm

22L bottle
SIZE:
47×25×26cm



Stand for bottle A-1
Weight: 715g
QTY: 12pcs
G.W: 12.7kgs
MEAS: 55.5×43×60.5cm



Stand for bottle A-2
Weight: 715g
QTY: 12pcs
G.W: 12.7kgs
MEAS: 55.5×43×60.5cm



Stand for bottle B-1
Weight: 593g
QTY: 12pcs
G.W: 10.9kgs
MEAS: 67.5×32.5×72cm

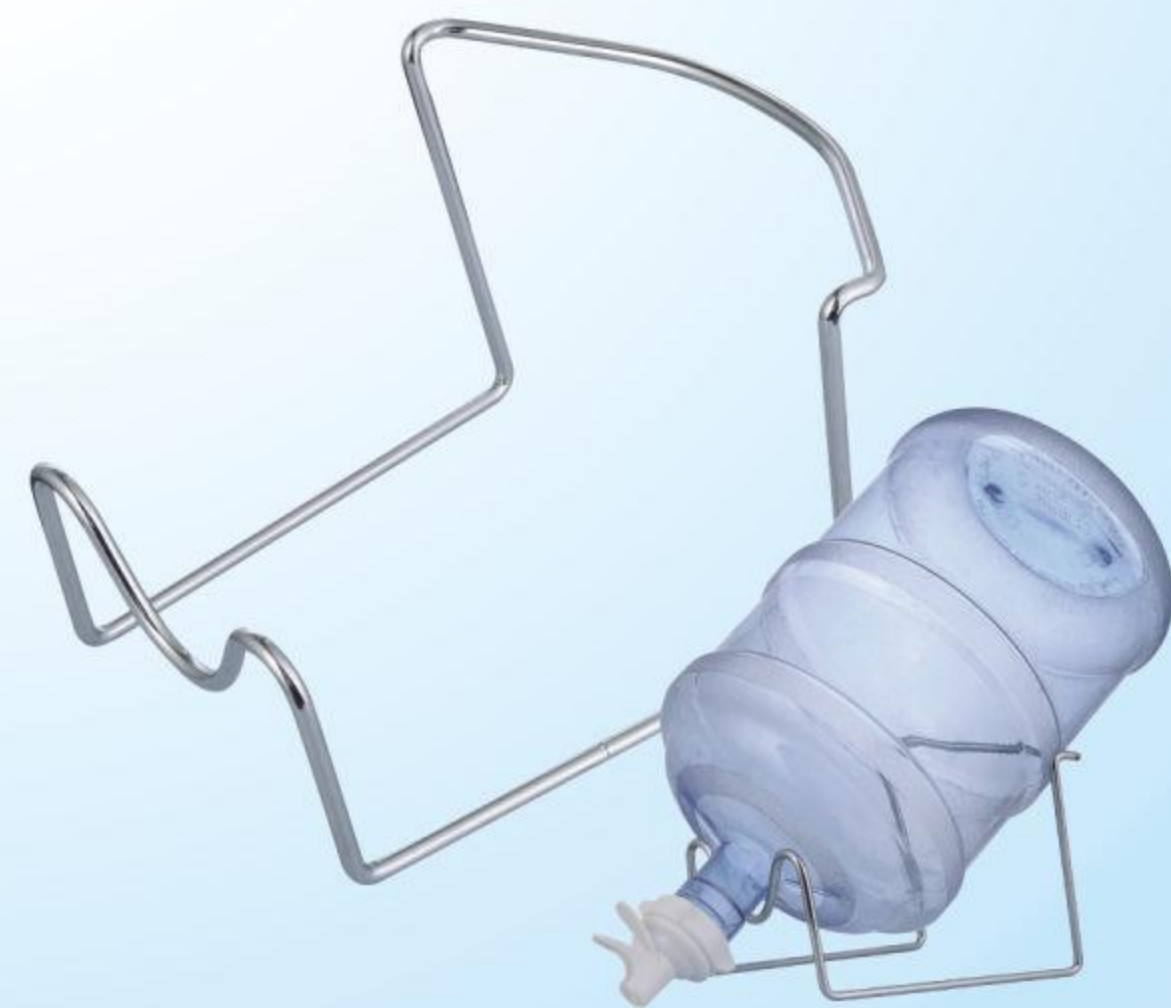

Stand for bottle B-2
Weight: 623g
QTY: 12pcs
G.W: 11.5kgs
MEAS: 77×32×73cm



Stand for bottle C
Weight:
QTY: 12pcs
G.W: 6.9kgs
MEAS: 63×27×27cm



Stand for bottle D
Weight: 380g
QTY: 12pcs
G.W: 5kgs
MEAS: 37.5×26×20cm

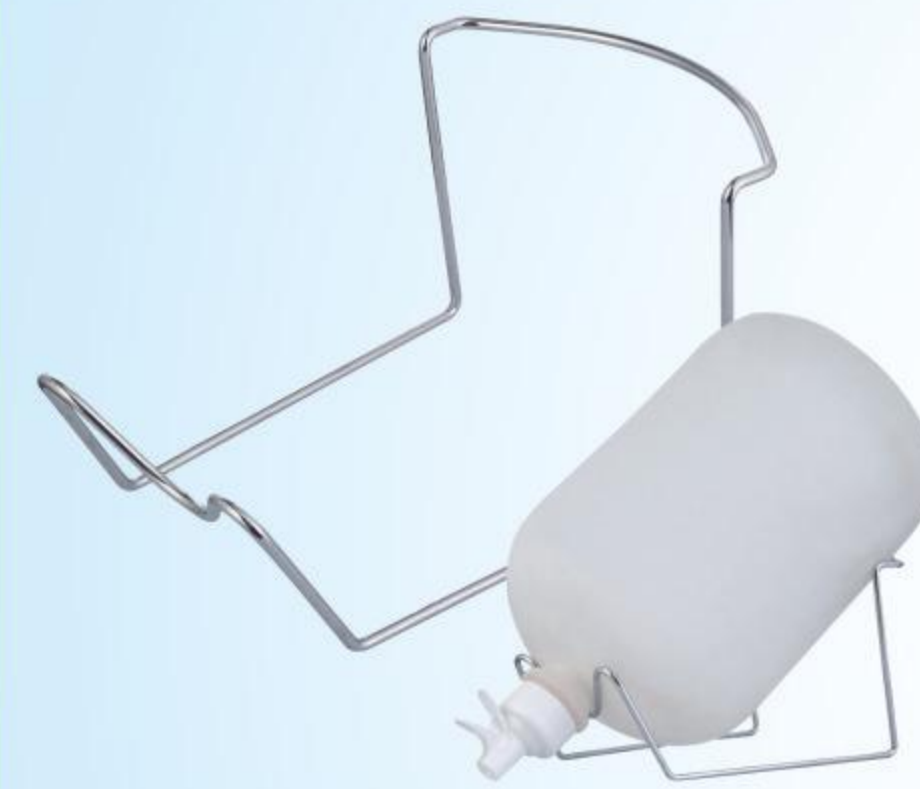

Stand for bottle E



Handle for bottle
● ● ●
Weight: 76g
QTY: 150pcs
G.W: 12.0kgs
MEAS: 56×36×26cm



Handle for bottle-B
● ● ●
Weight: 100g
QTY: 80pcs
G.W: 8.5kgs
MEAS: 56×36×26CM

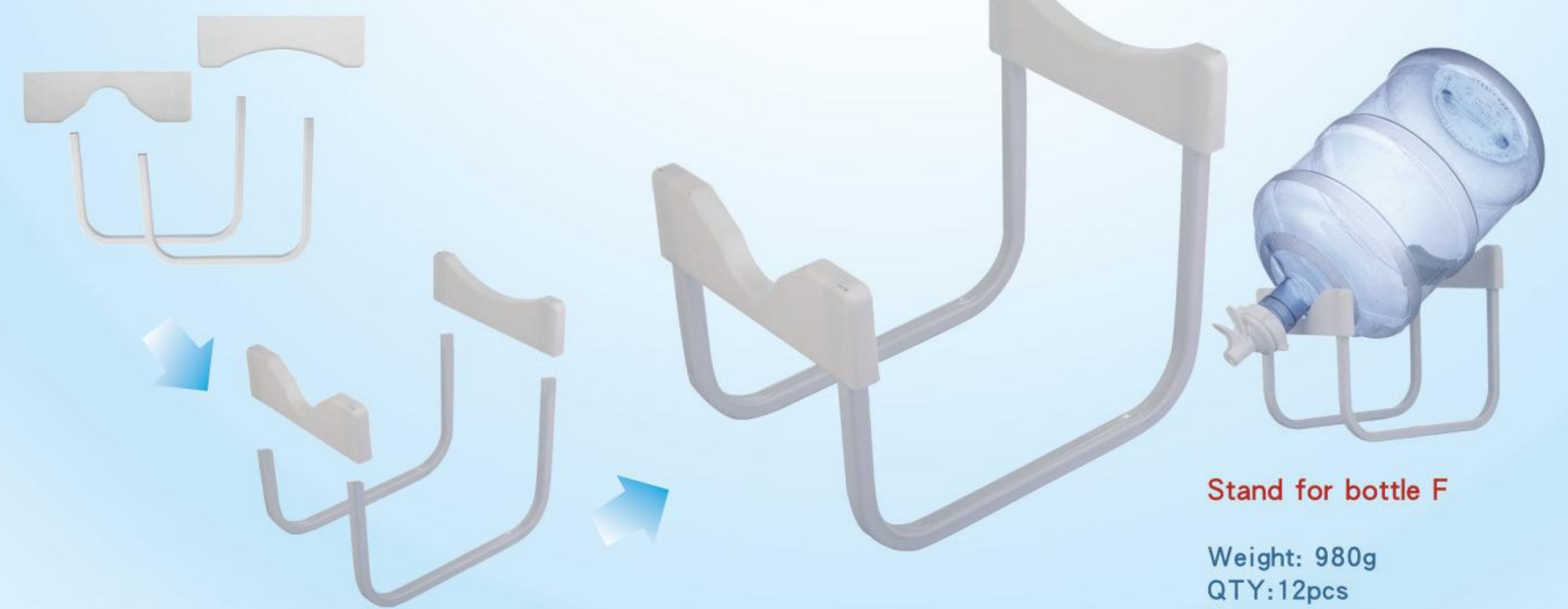

Stand for bottle F

Weight: 980g
QTY: 12pcs
G.W: 10.8kgs
MEAS: 63×34×47cm

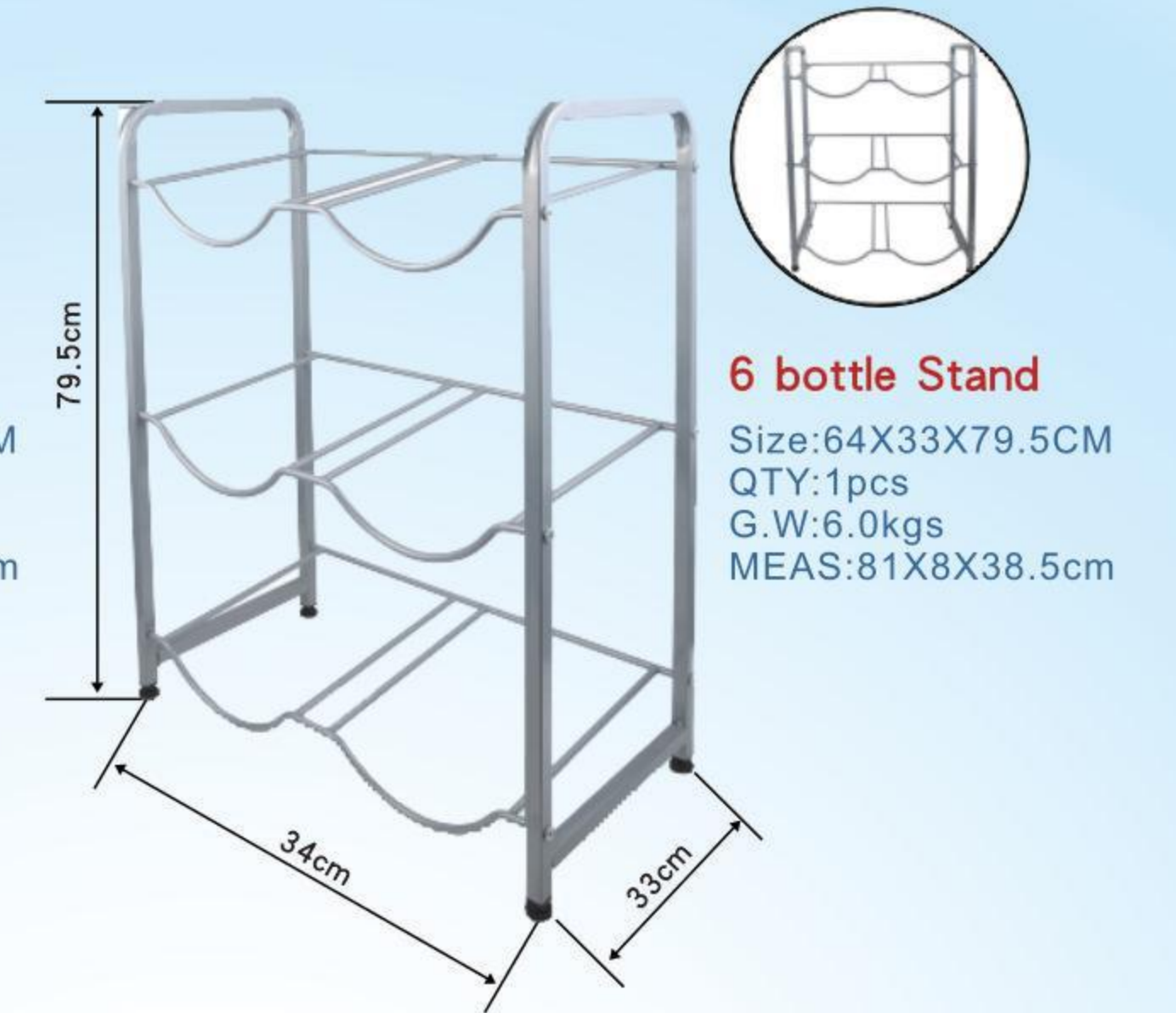
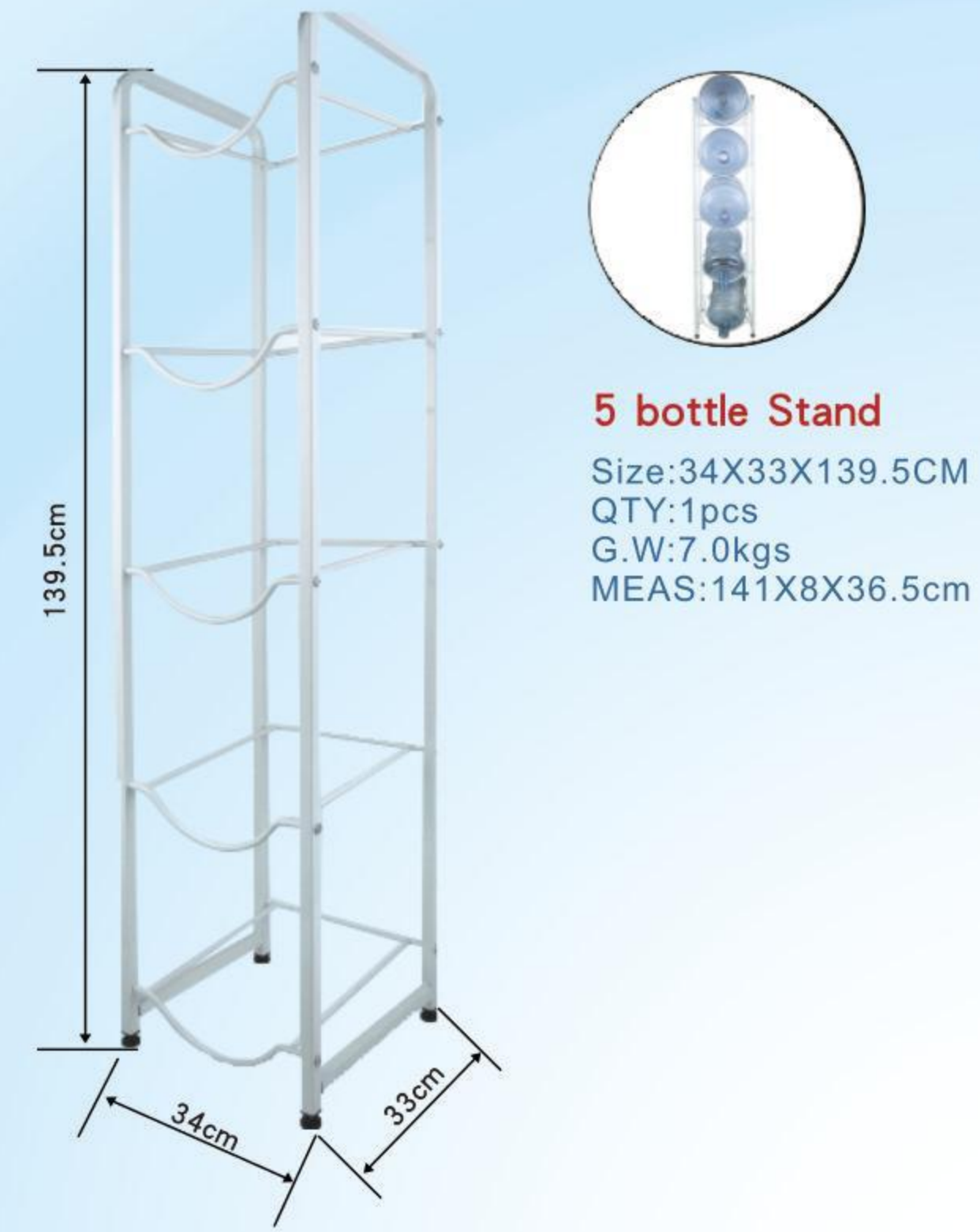

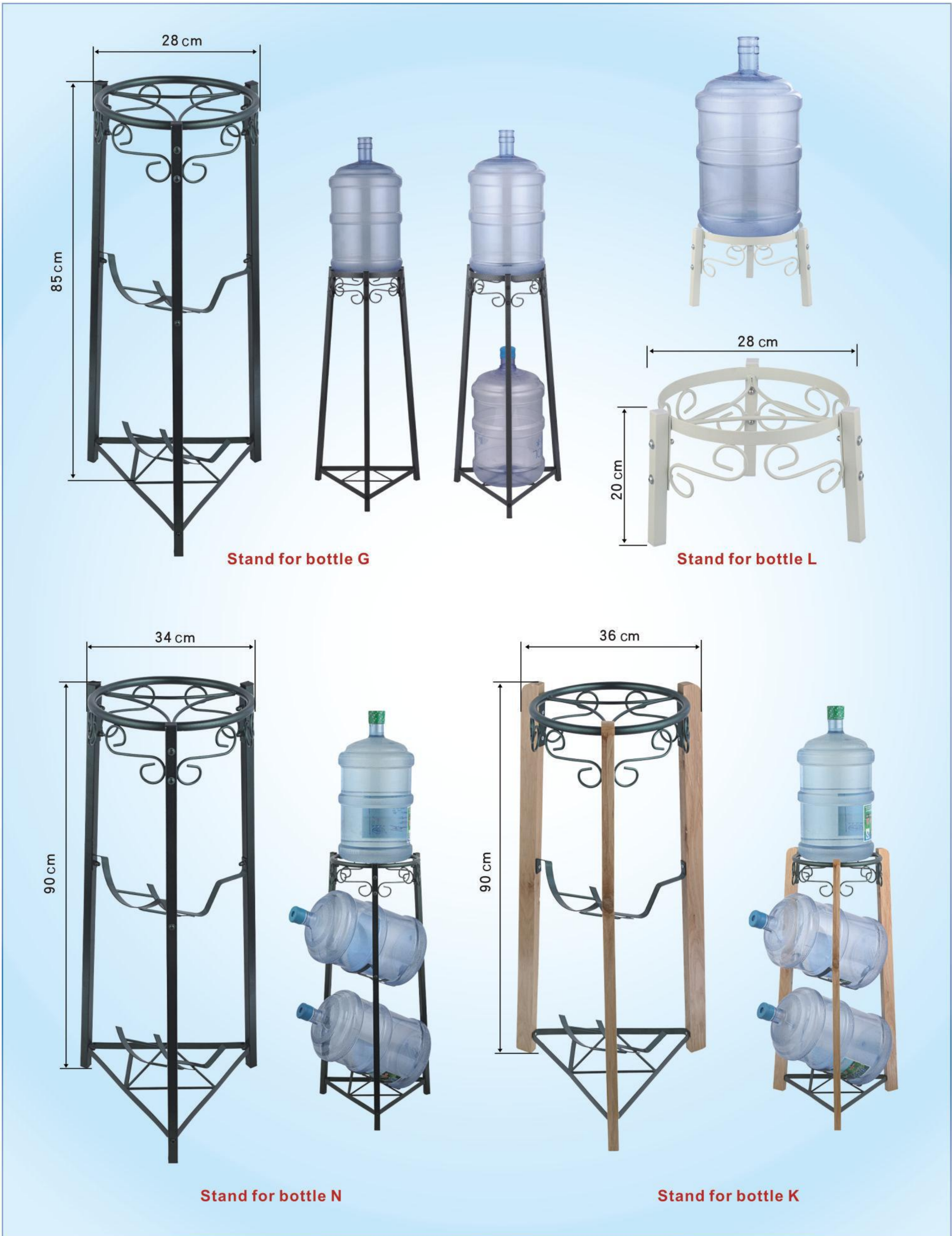



Faucet for bottle A
Weight: 62g
QTY:125pcs
G.W:8.6kgs
MEAS:56 X 36 X 26cm



Faucet for bottle B
Weight: 65g
QTY:125pcs
G.W:9.0kgs
MEAS:56 X 36 X 26cm



Faucet for bottle C
Weight: 39g
QTY:200pcs
G.W: 8.6kgs
MEAS:56 X 36 X 26cm



Faucet for bottle D
Weight: 65g
QTY:125pcs
G.W:9.0kgs
MEAS:56 X 36 X 26cm



Faucet for bottle E
Weight: 30g
QTY:250pcs
G.W:8.3kgs
MEAS:56 X 36 X 26cm



Faucet for bottle F
Weight: 44g
QTY:180pcs
G.W:8.8kgs
MEAS:56 X 36 X 26cm



Faucet for bottle G
Weight: 70g
QTY:100pcs
G.W:7.5kgs
MEAS:56 X 36 X 26cm



Faucet for bottle H
Weight: 47g
QTY:200pcs
G.W:10kgs
MEAS:56 X 36 X 26cm



Cup Holder A



磁铁固定块
Magnet fixed block
G.W:419g
QTY:24pcs
G.W:12.3kgs
MEAS:61.5X38X45cm



螺丝固定块
Screw fixed block
G.W:278g
QTY:24pcs
G.W: 9kgs
MEAS:61.5X38X45cm

纸杯架
Cup Holder B

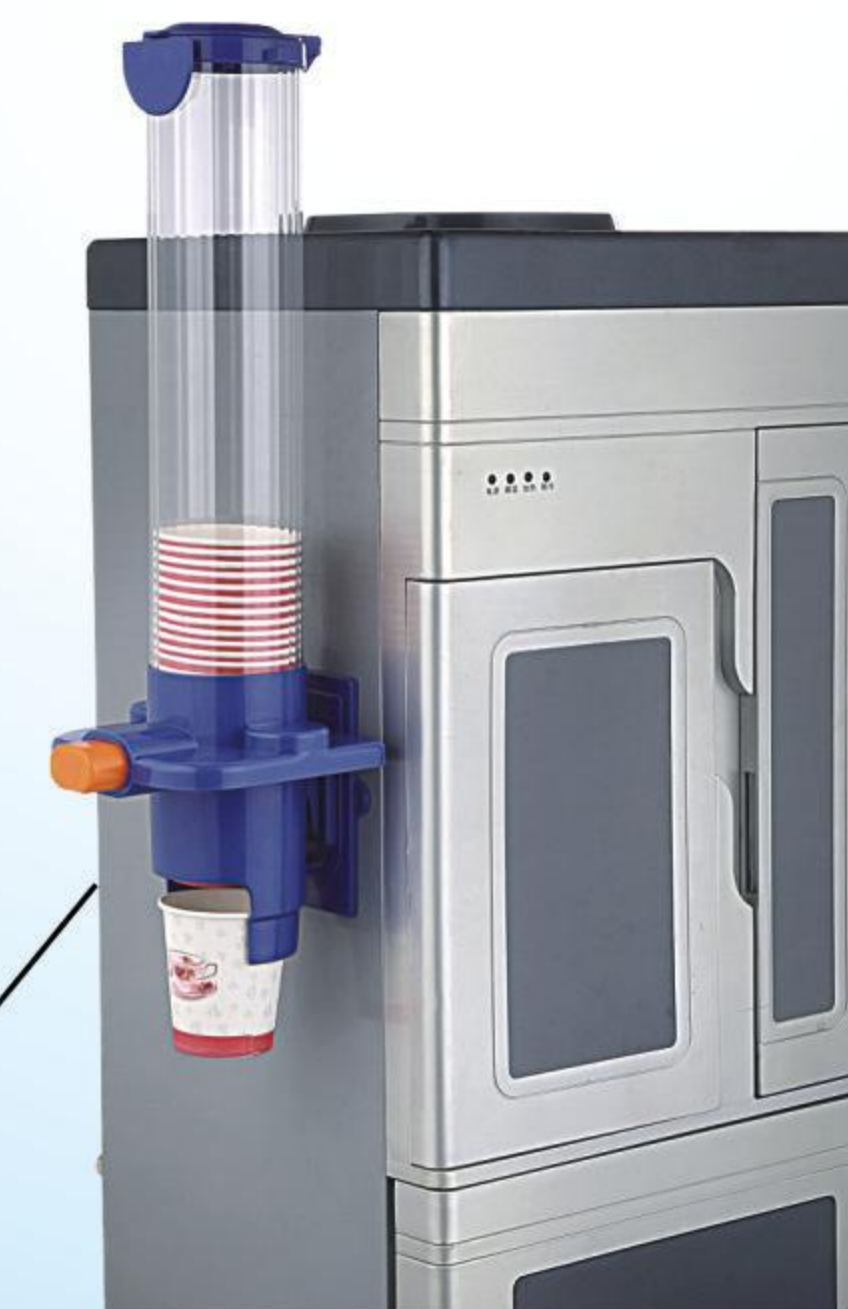

QTY:6pcs
G.W: 4.6kgs
MEAS: 50X33X47cm